



① 1x



② 1x



③ 1x

④ 1x



⑤ 1x



⑥ 1x



⑦ 1x



⑧ 1x

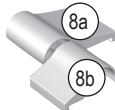

⑨ 1x



⑩ 2x



⑪ 4x



⑫ 2x



239 982 - 239 985
 239 900 - 239 905

239 912 - 239 918



Ⓐ 2x



Ⓑ 1x

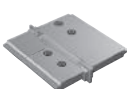

Ⓒ 1x

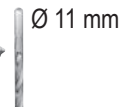

⊕ SW3

⊕ SW6



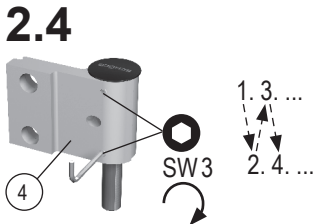
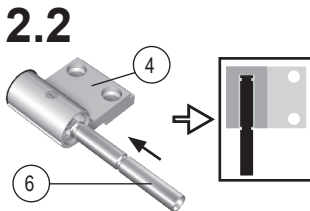
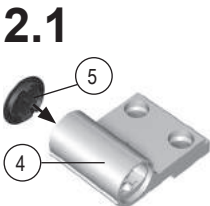
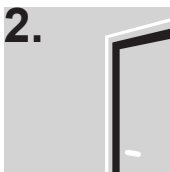
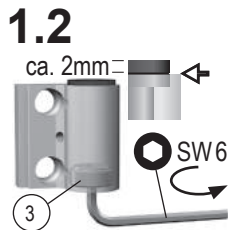
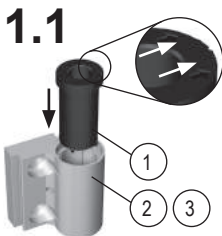
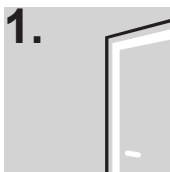

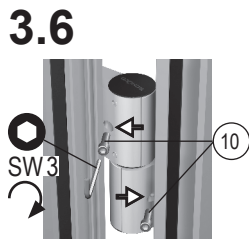
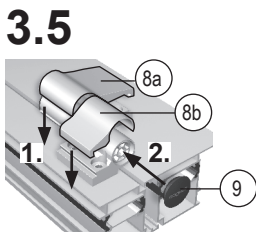
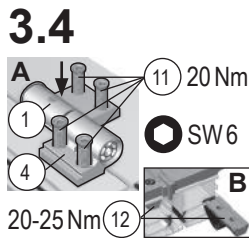
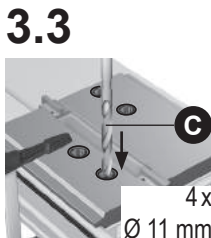
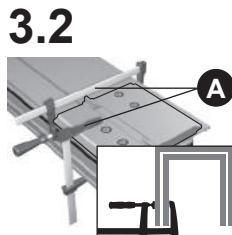
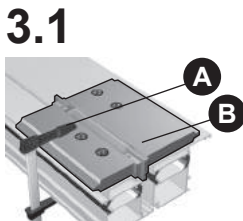
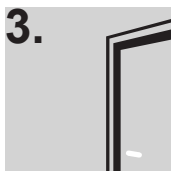

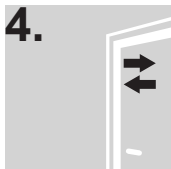

4.1



4.2



4.3

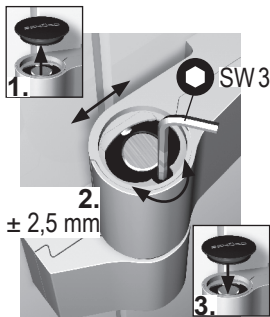

4.4

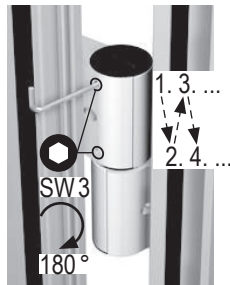

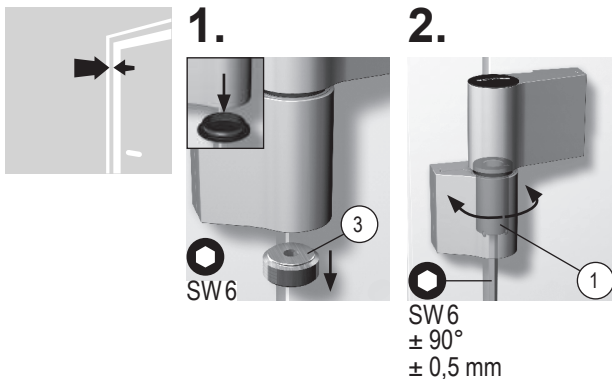
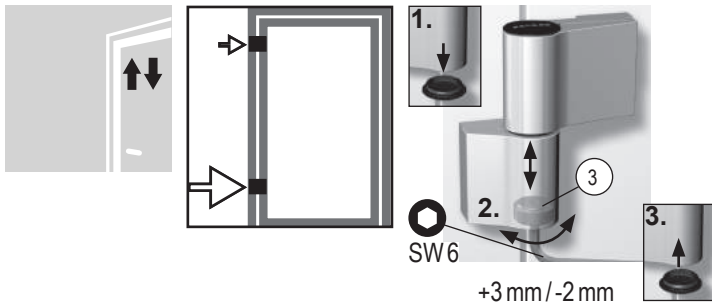

2a.

-0,5 mm

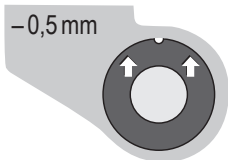

2b.

0 mm

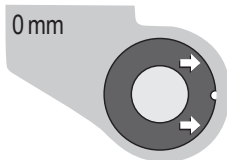

2c.

+0,5 mm

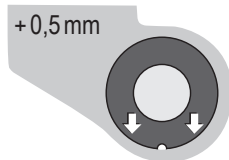

3.

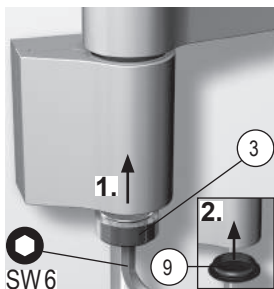

1

